



The N610i digital label press

High print quality at flexo speeds



Combines the productivity of flexo with the flexibility of digital



<http://bit.ly/2eEvUs>
Scan the code to find more about Domino N610i

Domino. Do more.

The smarter way to print labels

For label printers, the Domino **N610i**, with up to seven colours including opaque white, 600dpi 'native' print resolution and operating speeds up to 75m/min (246ft/min), combines the productivity of flexo printing with the flexibility offered by rapid job change digital technology.

This means an investment that provides added potential for greater sales growth and increased profitability, whilst reducing production cost and complexity.

Applications

The **N610i** uses vibrant UV curable inks designed for a range of industry standard self-adhesive label substrates including coated paper, polypropylene, polyethylene and now also for shrink sleeves.

Ideal for:

Industrial, home, personal care, security, health and safety, automotive, chemical, pharmaceutical, food and beverage sectors*



*Subject to an effective migration barrier being in place.

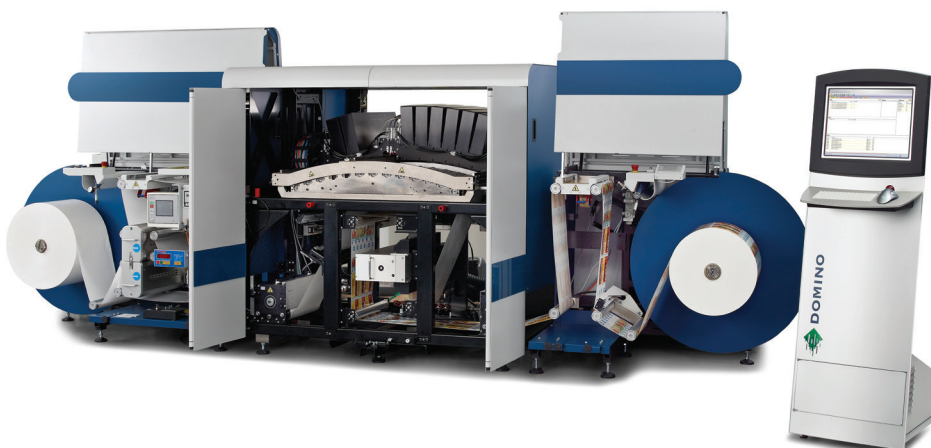

Customer Quote

"It is the quality of the print, the cooperation with the people and the service that we receive from our partner, as that is how we see Domino. We are capable of entering markets for which I'm 100% convinced we would not have reached if we would not have bought the Domino **N610i**."

Raf Joos,
CEO, ASQ Labels, Belgium



<http://bit.ly/2gl6Ua5>

The highest digital productivity

Production capacity

With a 1m (40") diameter roll unwind capable of handling up to 340mm (13.4") wide media and the widest print width (333mm or 13.11") of any Kyocera print head based label press, the **N610i** can process up to 3000 linear metres (9842 linear feet) or 1000m² (10760 ft²) of material per hour in high quality mode.

Waste saving

The Domino **i-Tech WebRev** manages substrate type changes and unplanned stoppages through a web reverse function. For these events, even with in-line finishing, web waste can be limited to less than 2m (6ft) and manual intervention minimised.

Printing at speed

The High Quality mode can print up to 92% of Pantone colours plus high opacity white at 50m/min (164ft/min). In the new Rapid Mode, the **N610i** is capable of printing at 75m/min (246ft/min) with optimised performance at 70m/min (230ft/min) which will still accurately reproduce up to 90% of the Pantone range, delivering unparalleled levels of quality and performance.



Customer Quote

"Scrap and labour savings, since moving this job to the Domino, is huge. With the Domino we can run in ONE HOUR what we used to run in an entire shift on flexo. We have only been running it for one month and we have already seen an increase in sales because of the Domino **N610i**."

Dave Ferguson,
President, McCourt Label, USA



<http://bit.ly/2vOPMv8>

The best ink jet print quality

It's not just about resolution

Even though Domino uses high resolution print heads from Kyocera at 600dpi, delivering more dots per inch than many competitive systems, this alone does not deliver the best ink jet quality. To achieve this, print head integration, precise web transport, robust components ie Corona and UV, bespoke workflow and the highest quality inks are all essential to ensure the best print results.



Domino. Do more.

The most reliable digital solution

It's just so simple

Ink jet technology is non-contact, with few moving parts, no printing plates, no drums, no blankets and no complex maintenance programmes. The time to change from printing one job to another is instantaneous with practically no substrate waste.



Jets that keep jetting

Domino's quality controlled UV inks are constantly circulated around the print head by the innovative **i-Tech ActiFlow** ink circulation system, even when printing has stopped. **ActiFlow** degasses the ink, preventing air bubbles forming, which can impact nozzle performance.

Automated maintenance

The revolutionary **i-Tech CleanCap** automated print head cleaning and capping technology is a consistently controlled process which reduces manual operator intervention meaning that daily manual head wiping is now a thing of the past!



Ink circulates in every part of the white ink system to provide the ultimate reliability

Domino **i-Tech UltraMix™** ink tank continuously circulates the white ink ensuring the pigment does not settle, but stays in suspension at all times, providing consistent results and enhanced reliability.

The Domino heavily pigmented **i-Tech TrapLess™** print bar has a unique design removing all potential ink traps where pigment can conglomerate. This helps to avoid the risk of early life nozzle failure that would impact print quality and reliability.



Domino N610i White
i-Tech UltraMix™ Ink Tank

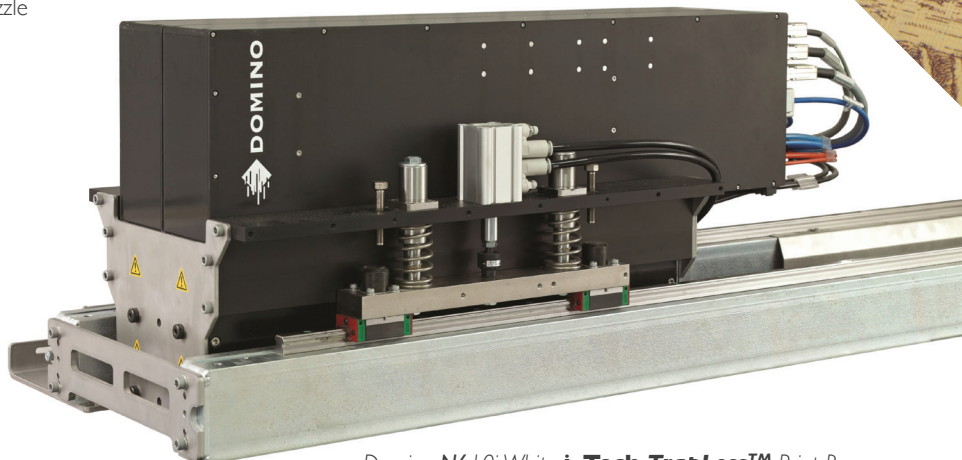

Domino N610i White **i-Tech TrapLess™** Print Bar

Highest opacity digital white

The N610i White provides the highest opacity (at 72%) screen-like, high-impact appearance, but with the operational flexibility of a digital process.

Silk screen-like printing replacement with a difference

There are no screens to be produced in order to get that opaque bold two dimensional textured effect typically only possible with screen printing technology. N610i White is clean to operate with almost no maintenance, efficiently providing this high impact printing in any quantities with no waste or time required to change from printing one job to another.

Customer Quote

"It is a very opaque white – it looks like it's been screen printed. That was the moment we were won over by the Domino N610i!"

Raf Joos,
CEO, ASQ Labels, Belgium



<http://bit.ly/2gL6UaS>



Textures by Domino

Increased shelf edge appeal is achieved due to the highly reflective nature of the print. Unique digital textured effects can open up new applications for Domino N610i press owners.

Unique textured label printing is achieved at speeds up to 50m/min (164ft/min). This feature can also be used to substitute premium priced textured substrates with Domino's textured print on standard paper, PP and PE materials.

Make your labels stand out from the crowd

- ✓ Add value - Offer premium product branding with enhanced shelf appeal
- ✓ Competitive advantage - Win additional business based on unique textured printing capability
- ✓ Creative designs - Endless textured designs on part or all of the label
- ✓ Cost-effective - Can be used as a replacement for screen printing or as a substitute for premium textured substrates
- ✓ Personalisation - Combine with variable data printing for completely unique product offerings

Textures

by Domino

Domino. Do more.

Domino UV90 Ink Set

Designed to deliver the widest gamut whilst also delivering the key mechanical features and benefits of ink jet over toner based digital printing technologies. Provides superior adhesion with unparalleled resistance to heat & cold, sunlight, chemical and saline attack and abrasion to maintain the highest quality through the life of the final product.

Our colour range

In today's fast evolving retail marketplace, the importance of colour in product packaging cannot be over-emphasised. The N610i provides brand owners and designers the scope to create designs with a far wider colour gamut cost-effectively.

Our seven colour press can achieve in excess of 92% of the Pantone® colour range without the need to make plates or the complexity of mixing spot colours.

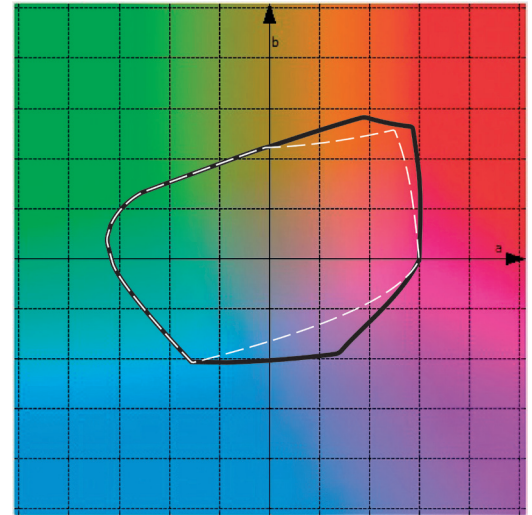

White dashed - standard gamut (CMYK)
Black - extended gamut (CMYKOV)

UV90 colour gamut

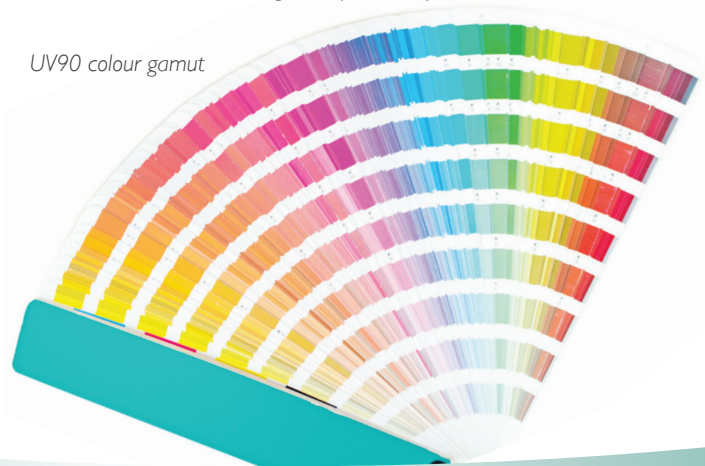

Provides high resistance to:

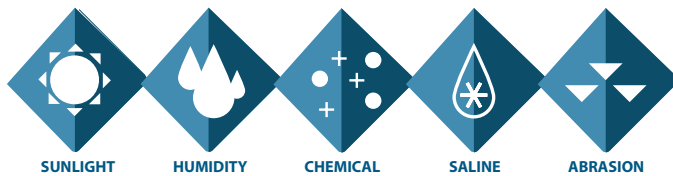

Adhesion & Abrasion

Although vital for industrial applications, adhesion and abrasion are important for all printing applications to ensure the finished goods survive the journey to the shelf in optimum condition and then offer the longest possible shelf life.

Tested using the industry standard cross hatch and tape tests, the **Domino UV90** inks maintain full adhesion on the widest range of substrates and remain highly abrasion resistant to maximise shelf appeal.

This degree of adhesion removes the need to pre-coat or varnish most substrate types, saving significant time and money.



Lightfastness

This is a property of the ink colourants that describes how permanent, and thus resistant to fading, they are when exposed to UV radiation.

Lightfastness indicates the suitability of the ink to be used in different applications, with those aimed for outdoors use and long-term direct sun exposure requiring very good resistance to fading and higher level of the lightfastness.

Measured using the Blue Wool Scale, a widely adopted standard used to express the lightfastness of pigments and dyes, the new range of **Domino UV90** inks achieve the highest possible score of eight across a range of substrates, offering the maximum resistance to fade within the industry.

BLUE WOOL SCALE RATING	APPEARANCE
BWS1	
BWS2	
BWS3	
BWS4	
BWS5	
BWS6	
BWS7	
BWS8	

SUBSTRATE	UV90WT	UV90YL	UV90OR	UV90MG	UV90VL	UV90CY	UV90BK
PP Top White	8	8	8	8	8	8	8
PE 85 TC	8	8	8	7/8	8	8	8
MC Primecoat	7/8	8	8	6	8	8	8

Shrink Sleeves

This removes the need to use traditional flexographic printing processes, with the associated high waste costs and long set-up times and offers a much more cost effective solution for medium length production than slow speed toner:

Domino's **UV90** ink set is the first and only high-speed UV ink jet solution capable of maintaining full adhesion after the heat-sensitive shrink labelling substrate has been shrunk to its maximum level, often down to 35% or less of its original size.



Compliance for food packaging

The **Domino UV90** ink set is both Swiss Ordinance and EuPIA compliant for non-food contact food packaging materials.

NOTE: Domino does not claim that its inks are 'Low Migration' since this statement is highly misleading. Domino recommends using migration compliant inks, working to recommended GMP guidelines and then unless an absolute or known functional barrier is present, performing migration testing on each ink and substrate combination used.



Domino. Do more.

N6 I0i Reel-to-reel

The Domino **N6 I0i** in reel-to-reel format is the ultimate label press providing total flexibility for printing short runs or where multiple finishing and die cut changes downstream are required.

Available in 4, 5, 6 and 7 colour options and capable of delivering consistent print quality day-in, day-out, the **N6 I0i** delivers the highest production capabilities whilst offering total flexibility.

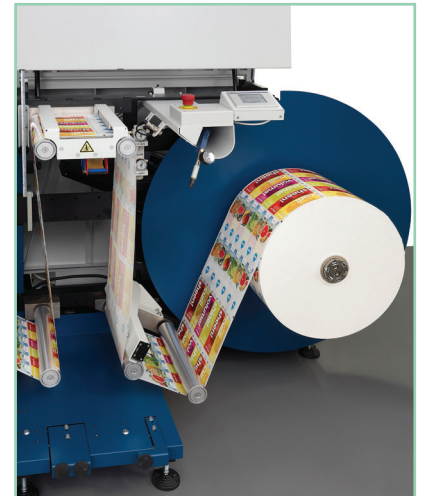

N6 I0i with near line finishing

Does your job structure suit a combination of in-line/offline finishing? The **N6 I0i** has been designed to flexibly job-to-job work as a standalone reel-to-reel press or interfaced with industry leading digital finishing solutions including those from A B Graphic International, Converting Equipment International (CEI), Delta Industries, GM, Grafotronic and SMAG Graphique.



Domino **N6 I0i** with near line finishing from ABG

N610i Hybrid

Including the N610i Integration Module

Can be supplied as part of a fully integrated hybrid press working with partners such as ABG, CEI, Delta Industries, Lombardi, MPS & OMET.

You can include flexo stations before and after the **N610i** module as well as screen and foiling stations. It meets a wider range of product design needs, but still provides digital quick job change, and is well suited for multiple SKUs. High impact labels delivered in an efficient single process with white roll in, to final finished product output.

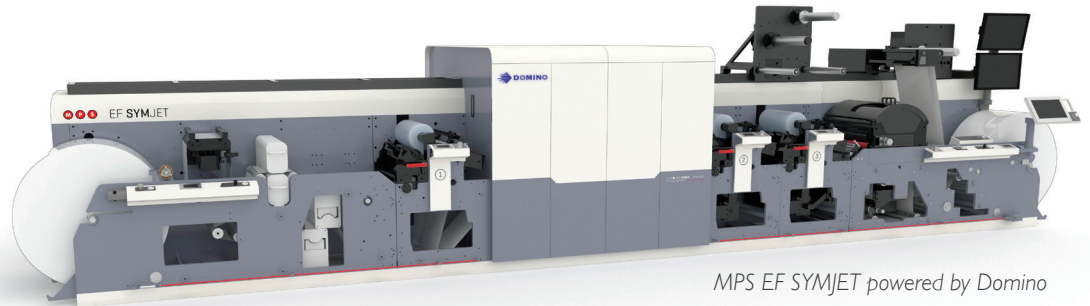

MPS EF SYMJET powered by Domino

Combined with the widest range of analogue printing and finishing solutions, the Domino **N610i** Integration Module is rapidly becoming the defacto standard for converters looking for maximum flexibility and future-proofed production capabilities.



CEI Bossjet powered by Domino



ABG Digicon powered by Domino

Through the use of web buffers and **i-Tech WebRev**, even with in-line finishing or in hybrid formats, waste associated with a substrate change or unplanned stoppage can be limited to 2m (6ft).

Domino. Do more.

Workflow

The new Domino Workflow combines the industry standard Esko Digital Front End v2.0 (DFE) with a new high speed Domino Screen Pro screener and Job Definition File (JDF) server to provide a highly configurable workflow. It can be used in a fully automated mode, in a manual control mode and in combination with the Domino Application Programming Interface (API) for a unified hybrid press or in-line finishing solution.

The Domino Workflow is built to maximise the latest Adobe PDF Print Engine (APPE) and offers full support for the industry standard PDF/VT variable data printing (VDP) file format. It is also fully JDF/JMF compatible ensuring full integration with Management Information Systems (MIS).



Workflow efficiency

The Domino Workflow in fully automated mode streamlines the workflow process, with increased job processing speed, removing the need for manual interventions and thus the risk of introducing errors.

Domino ScreenPro is available in two versions, Standard and High Speed (HS) for even faster processing. The HS version processes files in parallel to the Esko DFE, utilising the full processing power of the latest Domino Workflow server platform to deliver a near 2:1 rip-to-print ratio.

Colour Management Tools

The Esko DFE v2.0 RIP and colour management suite includes many advanced features such as a simple to use spot colour refinement tool for accurately matching your customers' colours job after job.



Automation

Complete workflow automation removes the need for operator intervention and allows full integration into your Management Information System (MIS). It also provides seamless integration with the Esko Automation Engine via the Print-to-Digital Press Module, allowing upstream integration with designers and pre-press functions.

Regular jobs can be set up such that after order entry, the next touch point is selecting print at the N6 IOi control desk.



JDF/JMF Support

The Domino Workflow accepts industry standard JDF input files to drive the press and provides industry standard JMF feedback to the customer MIS system, providing job status and production information, including ink usage.

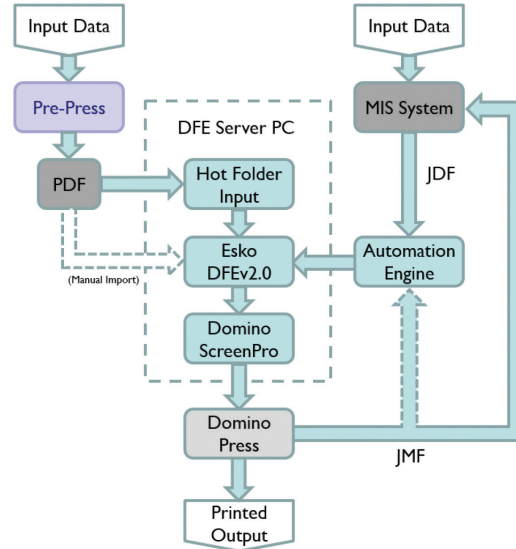

Variable Data Printing

Full Colour VDP Workflow

With the increase in demand for product personalisation, Domino's full colour variable data workflow printing not only allows variable text, barcodes and images to be printed, but also ensures the colours match your non-VDP content, even for 7 colour printing.

The Domino Workflow offers support for variable data printing via three options according to the pre-press systems in place: -

- Multipage PDF files
- PDF/VT files created in pre-press
- Support for Esko DeskPack VDP plugins for Illustrator allowing the expansion of VDP template files on the DFE using compatible Comma Separated Values (CSV) data files



Domino. Do more.

Take a closer look inside the N6 I0i

intelligent Technology

i-Tech components combine to create a system altogether more flexible and reliable.

1. Domino Ink Jetting Assemblies

Proprietary Domino ink jetting assemblies incorporate Kyocera print heads that deliver consistent print results and higher reliability than any other press using similar technology.

2. Ink Jet Engine

The **N6 I0i** can be configured as either:

- 4 colour CMYK
- 5 colour CMYKWW
- 6 colour CMYKOV
- 7 colour CMYKOVWW

All with 333mm (13.11") print width and web width up to 340mm (13.4")

3. i-Tech CleanCap

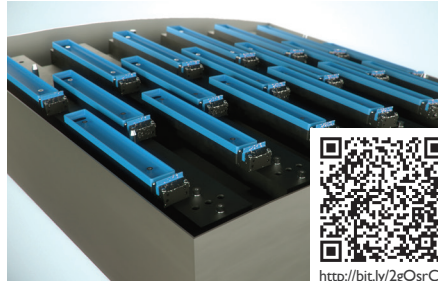

Automated print head cleaning and capping station ensures the highest print quality and productivity – all heads are cleaned within one minute.

4. i-Tech ActiFlow

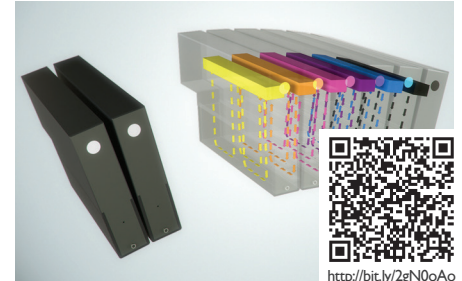

The ink circulation system keeps the ink continuously moving around the print head, maintaining a constant temperature and removing micro air bubbles, ensuring consistent print quality and reliability.

5. i-Tech StitchLink

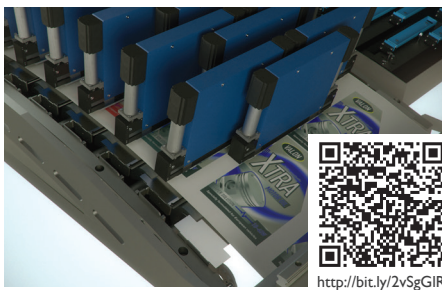

Micro-motor controller technology ensures that all heads are positioned precisely, calibrated to print as one, enabling seamless print across the full web width

6. Ink Cabinet

7. UV LED Pinning for CMYKOV and White

8. UV Curing GEW

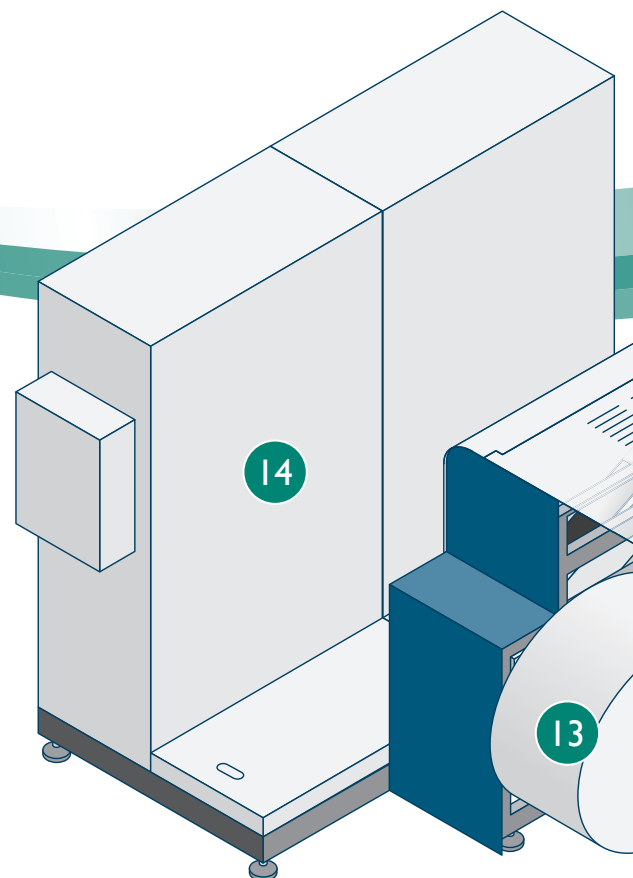

9. Tension Control

10. Web Guide

FMS

11. Corona

Vetaphone

12. Web Cleaner

Teknek dual sided web cleaner

13. Unwind & Rewind

Rolls up to 1000mm (40") diameter supported web

14. Temperature controlled electronics cabinet

15. Splice Detection System

Printing is paused and the print heads are automatically raised and then lowered after a poor splice has passed. The printing automatically continues in registration, wasting less than 3m of substrate

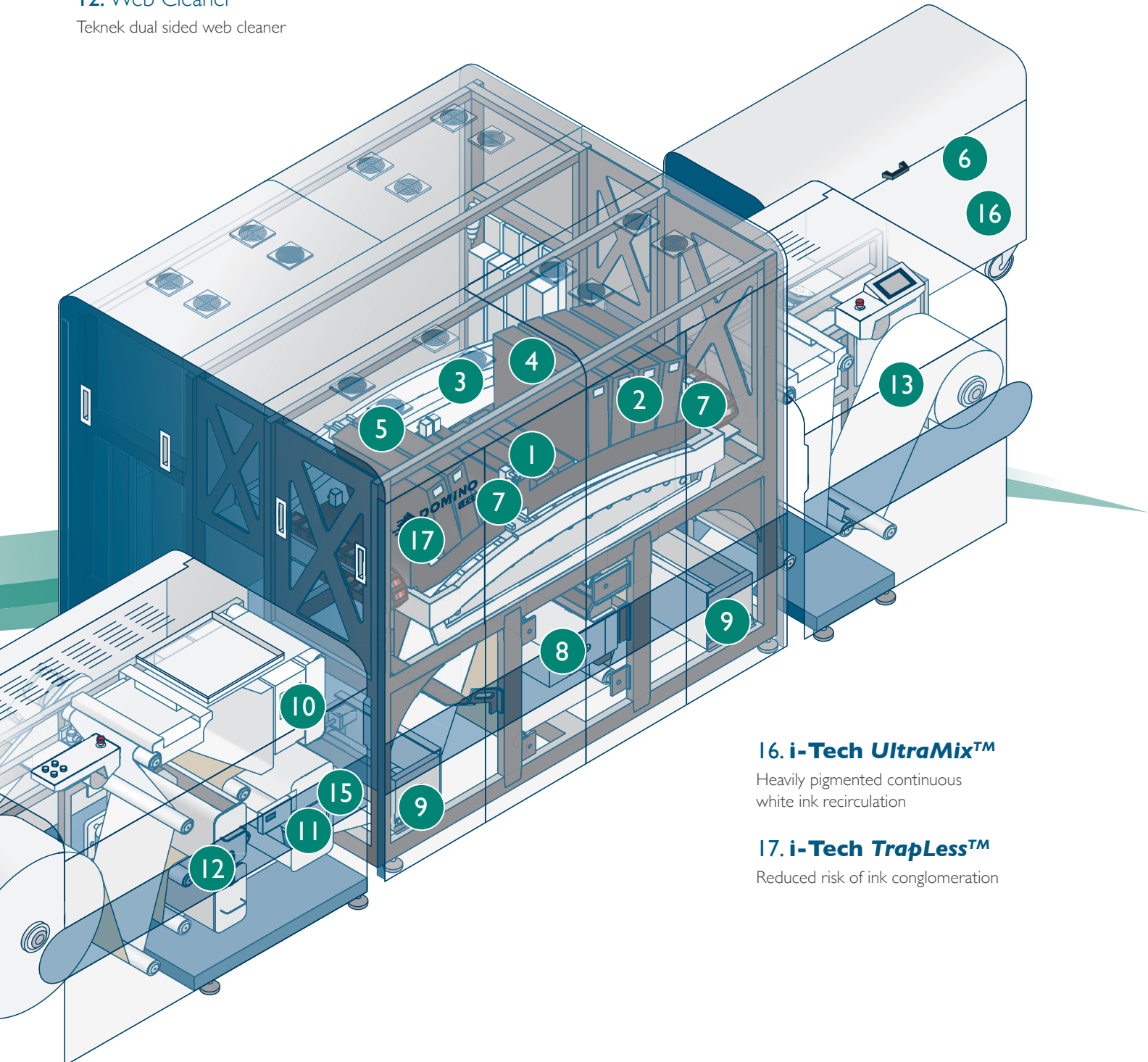

16. i-Tech UltraMix™

Heavily pigmented continuous white ink recirculation

17. i-Tech TrapLess™

Reduced risk of ink conglomeration

Domino. Do more.

Total Cost of Ownership

Simple cost of ownership tools help you to profile your production jobs and understand the relative return on investment of different printing technologies.

Your Domino representative will be pleased to help you understand the benefits of the N610i versus your existing production methods..

Simple tools to provide job specific crossover analysis between different technologies, as well as more in-depth total cost of ownership (TCO) calculations for a single job, or a range of different jobs, with varying run-lengths, versions, ink coverage, etc. which can then be compared to recorded metrics on job completion.

The analysis is based upon customer inputs, i.e. actual production data and costs. Truly understand where digital printing provides an advantage; shorter run, fast turnaround work, sampling, variable data jobs or where versioning is required.

Understand the impact waste, downtime and plate changes have on costs and production time to see how the N610i can save you money and deliver a significant return on investment.

Maximum Label Production Per Year

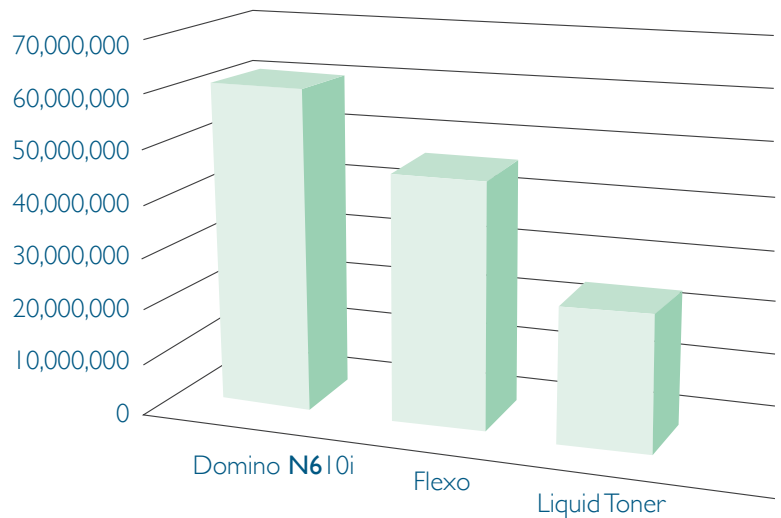

Download white paper
<http://bit.ly/2ygi7A2>

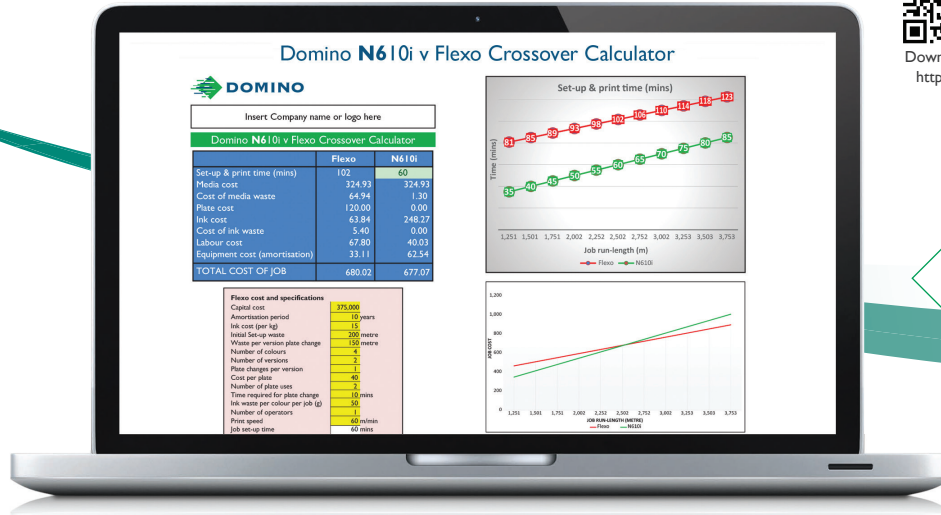

Greener credentials

Domino's commitment and investment in sound environmental practices means we frequently exceed the increasingly demanding governmental, industry and company standards and regulations. We are committed to minimising the consumption of natural resources and energy and the creation of waste. Our products are RoHS and WEEE compliant so that they are recyclable.

N610i

The N610i requires no plates, no plate making process or associated materials for washdown purposes and with fewer curing lamps than a flexo press, it uses less energy resulting in reduced costs.

It can create very little media waste – this can be less than 2m (6ft) per job/substrate change and the capability to 'print-on-demand' results in less over-printing and reduced storage requirements.

The N610i is supplied with UV curable inks representing an efficient use of our natural resources. Although UV curable inks are chemicals and need to be used correctly, they offer significant environmental benefits compared to solvent alternatives. Solvent inks include up to 95% volatile solvents that evaporate into the environment and require regular print head cleaning. N610i UV curable inks contain 1% volatile solvents.

About Domino

Founded in 1978, Domino Printing Sciences plc, has established a global reputation for the continual development and manufacture of total coding and printing technologies that meet the needs of its customers and set new industry standards in quality and reliability.

With over 100 digital ink jet presses sold and over 500 other digital ink jet installations based on the same product platform, Domino Digital Printing Solutions is the global industry leader.

Registered Office Details

Domino Printing Sciences plc
Trafalgar Way
Bar Hill
Cambridge
CB23 8TU
United Kingdom
Telephone: +44 (0)1954 782 551
www.dominoprinting.com

Through a global network of 25 subsidiary offices and in excess of 200 distributors, the Domino Group operates in over 120 countries employing over 2,700 people worldwide with manufacturing facilities situated in UK, China, Germany, India, Switzerland, Sweden and USA.

On 11 June 2015, the Domino Group was acquired by Brother Industries Limited.

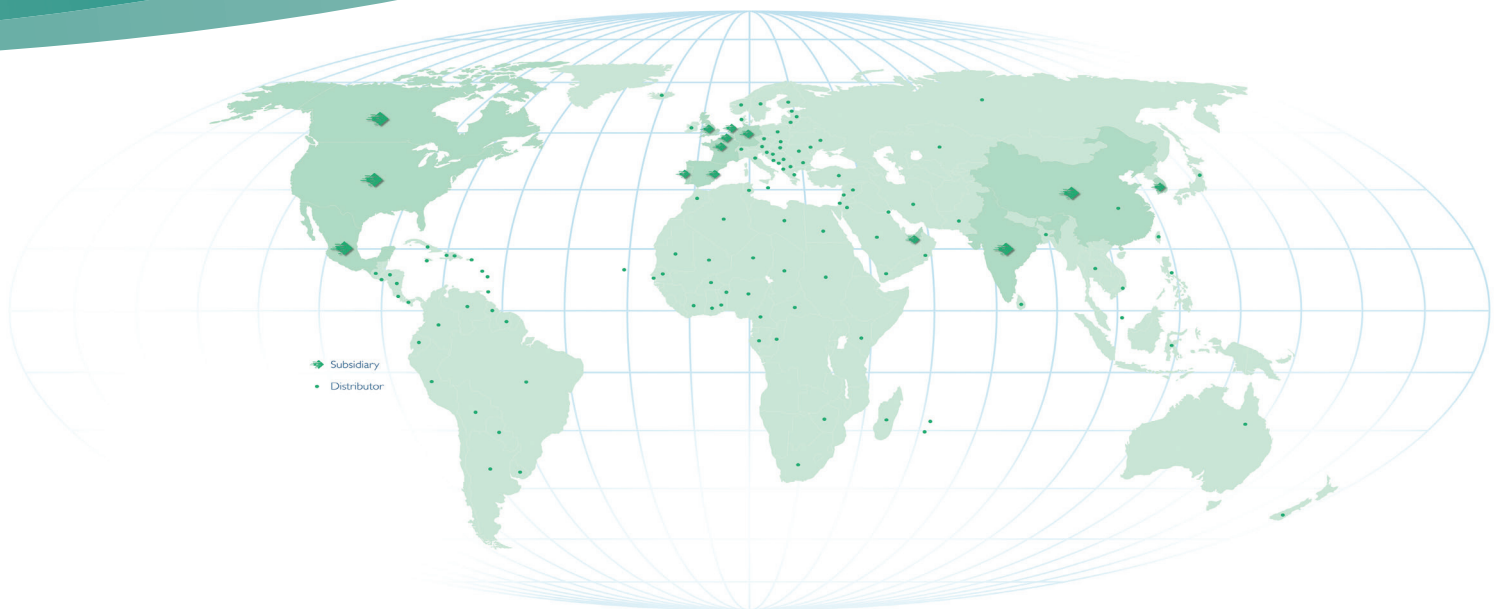

Domino is a world leader in printing and coding solutions utilising ink jet, laser, print and apply and thermal technologies

Domino. Do more.

Technical Specification:

Technology

- Piezo Drop on Demand ink jet

Printing Speed

- Up to 50m/min (164ft/min) High Quality Mode
- Up to 75m/min (246ft/min) Rapid Mode

Image Resolution

- 600dpi native including 4 greyscales (nominal 1340dpi)

Image Format

- 333mm (13.11") maximum print width

Web Width

- 200mm (7.9") to 340mm (13.4")

Media Type

- Polyethylene, polypropylene and paper self adhesive label stock
- Selected unsupported materials (films)

Inks

- UV curable Cyan, Magenta, Yellow, Black, Orange, Violet and White

Unwind/Rewind

- 1000mm (40") diameter
- Maximum roll weight: 300kg (661lbs)
- Servo driven tension control
- Corona treatment module
- Web cleaning
- Web guide module

Workflow

- ESKO DFE v2.0
- Domino ScreenPro & ScreenPro HS

Central Print Module

- Anti-static control
- Up to 7 colour print section
- UV LED pinning
- UV curing module

Options

- In-line finishing interface
- In-line inspection
- Variable data printing
- Chilled roller

Dimensions

- 5.614m (L) x 1.735m (H) x 1.925m (W) (1.0m minimum clearance required)
- 18.5ft (L) x 5.9ft (H) x 6.4ft (W) (3.3ft minimum clearance required)
- Ink cabinet: 1202mm (L) x 807mm (H) x 520mm (W) 47.3" (L) x 31.8" (H) x 20.5" (W)

Weight

- Unwind: 600kg (1323lbs)
- Printing section: Nominal 1500kg (3307lbs)
- Rewind: 400kg (882lbs)
- Power cabinet: 350kg (772lbs)
- Ink supply unit: 200kg (441lbs)

Services

- Three phase power - one 380-420V drop
- Compressed air - one drop @ 6-8 bar (90-115psi), clean and dry

Environment

- Optimal temperature range 20-22°C (68-72°F)
- Maximum temperature range 20-25°C (68-77°F)
- Ink storage 20-25°C (68-77°F)
- Optimum humidity range 40-60%
- Dust controlled environment preferred

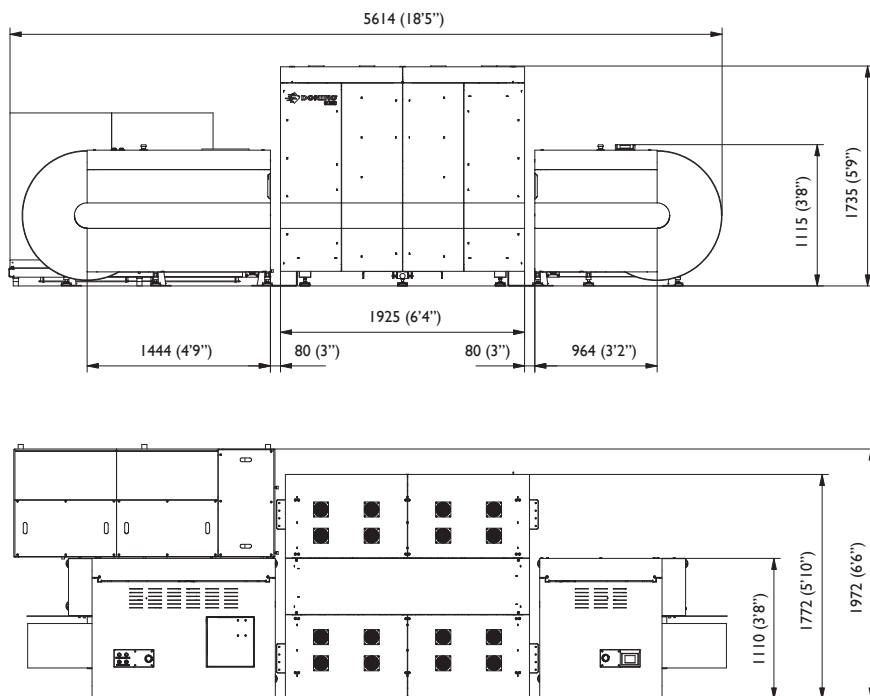

Dimensions in mm (feet/inches)

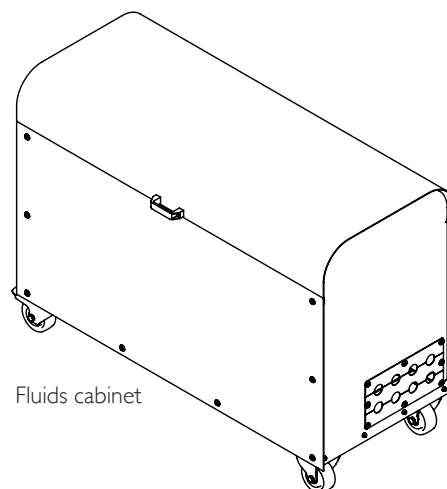

www.n610i.com

www.dominoprinting.com

YouTube™



<http://bit.ly/2gL6Ua5>

